

**Mosaic™**  
**LCS2 Cat. 6 RJ 45 socket**

Référence(s) : **765 03/04/05/06/07/22/23/44/46/61/62/63/64**  
**765 65/66/81/82/83/91/92/93/94/95/96**  
**794 61/62/64/65/92**

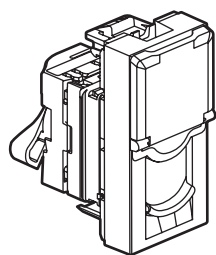

765 61

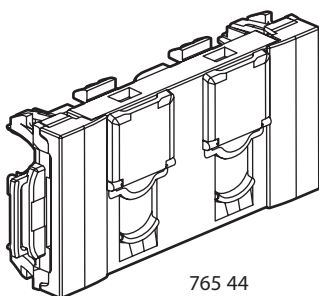

765 44

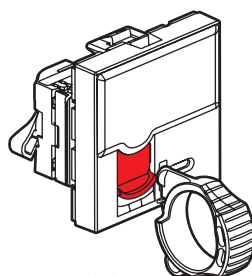

765 94

**CONTENTS**

Page

1. General characteristics .....	1
2. Presentation .....	2
3. Installation .....	2
4. Technical characteristics.....	2
5. Connection .....	2
6. Overall dimensions.....	2
7. Usual connection of RJ 45 sockets .....	3
8. Standards and approvals .....	3
9. Performance .....	4

**1. GENERAL CHARACTERISTICS**

Category 6 RJ 45 socket for high speed transmission (Gigabit Ethernet).

	Designation	Number of modules	UTP	FTP	STP	Weight (g)
	Cat. 6 UTP RJ 45 socket	1	765 61			13
	Cat. 6 UTP RJ 45 socket aluminium	1	794 61			13
	Cat. 6 FTP RJ 45 socket	1		765 62		13
	Cat. 6 FTP RJ 45 socket aluminium	1		794 62		13
	Cat. 6 STP RJ 45 socket	1			765 63	29
	Cat. 6 UTP RJ45 socket anti-bacterial	1	765 81			13
	Cat. 6 FTP RJ 45 socket anti-bacterial	1		765 82		18
	Cat. 6 STP RJ 45 socket anti-bacterial	1			765 83	29
	Cat. 6 UTP RJ 45 socket	2	765 64			18
	Cat. 6 UTP RJ 45 socket aluminium	2	794 64			18
	Cat. 6 FTP RJ 45 socket	2		765 65		18
	Cat. 6 FTP RJ 45 socket aluminium	2		794 65		18
	Cat. 6 FTP RJ 45 socket green	2		765 22		18
	Cat. 6 FTP RJ 45 socket orange	2		765 23		18

	Designation	Number of modules	UTP	FTP	STP	Weight (g)
	Cat. 6 UTP RJ 45 socket 90°	2	765 91			13
	Cat. 6 FTP RJ 45 socket 90°	2		765 92		18
	Cat. 6 FTP RJ 45 socket 90° aluminium	2		794 92		18
	Cat. 6 STP RJ 45 socket 90°	2			765 93	29
	Cat. 6 STP RJ 45 socket	2			765 66	34
	Cat. 6 UTP RJ 45 socket 45D	2	765 03			13
	Cat. 6 FTP RJ 45 socket 45D	2		765 05		18
	Cat. 6 STP RJ 45 socket 45D	2			765 07	46
	Cat. 6 UTP RJ 45x2 socket 45D	2	765 04			34
	Cat. 6 FTP RJ 45x2 socket 45D	2		765 06		34
	Cat. 6 UTP 2 x RJ 45 socket	4	765 44			43
	Cat. 6 FTP 2 x RJ 45 socket	4		765 46		43
	Cat. 6 UTP RJ 45 safety socket	2	765 94			16
	Cat. 6 FTP RJ 45 safety socket	2		765 95		16
	Cat. 6 FTP RJ 45 safety socket	2			765 96	29

# Mosaic™ LCS2 Cat. 6 RJ 45 socket

Référence(s) : 765 03/04/05/06/07/22/23/44/46/61/62/63/64  
765 65/66/81/82/83/91/92/93/94/95/96  
794 61/62/64/65/92

## 2. PRESENTATION

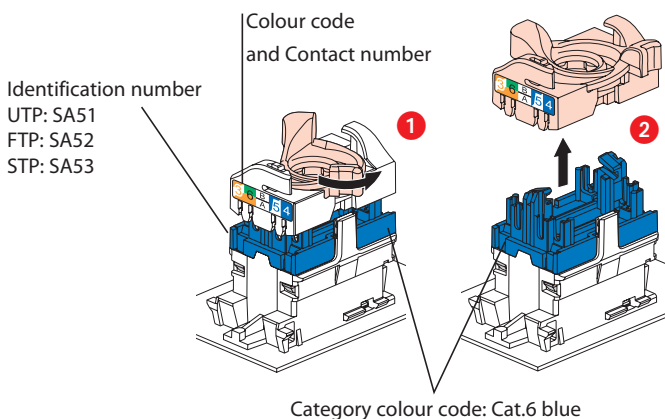

## 3. INSTALLATION

The mechanisms can be surface mounted or flush mounted.  
They can also be mounted in Mosaic Programme trunkings, columns, floor boxes and office modules (min. depth 40 mm)  
For Cat. Nos. 765 44/46, mounting in trunking only.

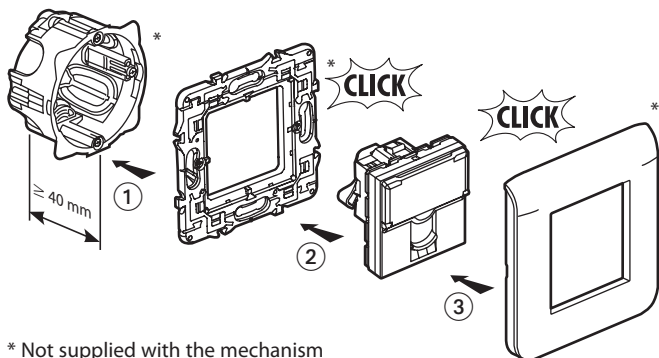

Rail mounting is possible using adaptor Cat. No. 802 99 (2 modules).  
The mechanisms can be mounted on thin panels with adaptors.  
Cat. No. 802 90 (1 modules), Cat. No. 802 91 (2 modules).  
Cat. No. 802 92 (2 x 1 vertical module).

### Cat. No. 765 94/95/96 Unlocking

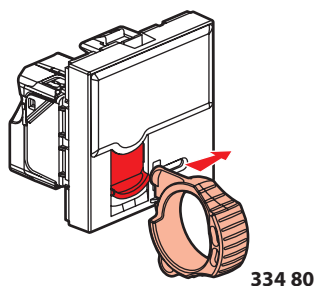

## 4. TECHNICAL CHARACTERISTICS

### 4.1 Material characteristics

Contacts: gold/nickel, minimum thickness of gold > 0.8 µm  
Metal parts: bronze, nickel, platinum, gold  
PBT polycarbonate  
For STP products the body and the spreader are made of metal alloy with a copper-nickel coating.

### 4.2 Electrical characteristics

Breakdown voltage ≥ 1000 V  
Contact resistance ≤ 20 mΩ  
Insulation resistance ≥ 500 MΩ at 100 V DC  
Connector tested and guaranteed under PoE restrictions, IEEE 802.3af standard and PoE+, draft standard 802.3at, up to 2500 on-load connections / disconnections.

Tests are carried out with 2 simultaneous PoE+ circuits for a minimum total power of 50 W.

### 4.3 Mechanical characteristics

Max. number of connections and disconnections: 5 without refreshing the wiring.  
Endurance: 2500 movements (plug insertion/withdrawal).  
IK03  
IP21

### 4.4 Climatic characteristics

Températures d'utilisation : - 40° C to + 70° C  
Humid heat cycle 21 days

## 5. CONNECTION

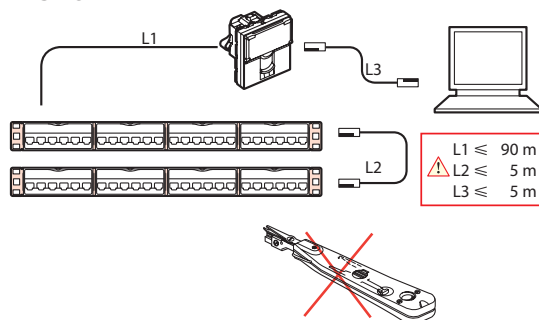

## 6. OVERALL DIMENSIONS

Front view:

765 22/23/64/65/66/91/92/93/94/95/96  
794 64/65/92

765 61/62/63/81/82/83  
794 61/62

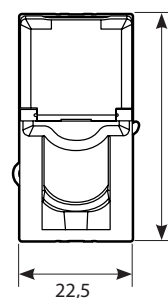
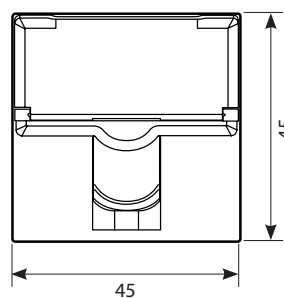

765 03/05/07

765 04/06

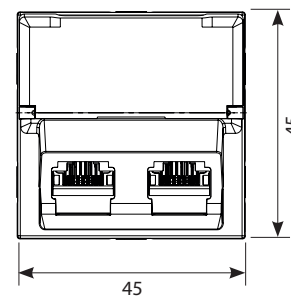
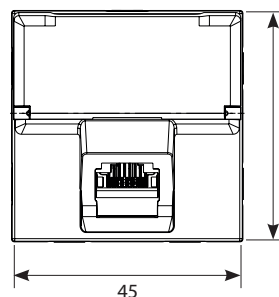

**Mosaic™**  
**LCS2 Cat. 6 RJ 45 socket**

Référence(s) : 765 03/04/05/06/07/22/23/44/46/61/62/63/64  
 765 65/66/81/82/83/91/92/93/94/95/96  
 794 61/62/64/65/92

**6. OVERALL DIMENSIONS (cont.)**

765 44/46

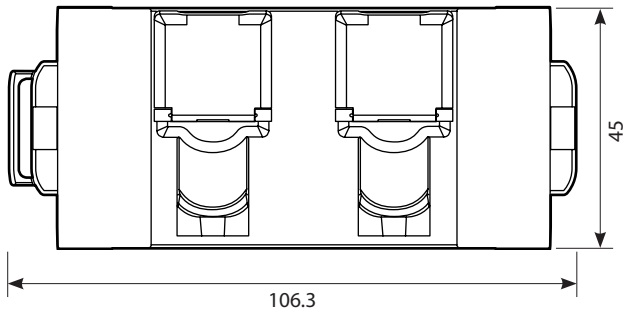

Side view:

765 22/23/44/46/61/62/64/65/81  
 765 82/91/92/94/95  
 794 61/62/64/65/92

765 03/04/05/06

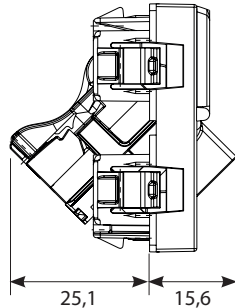
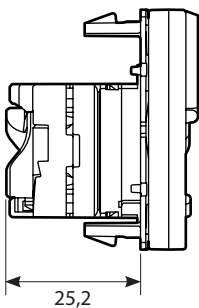

765 07/63/66/83/93/96

765 07

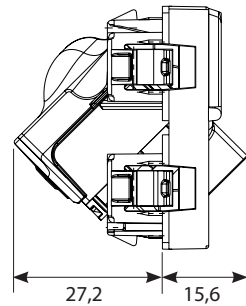
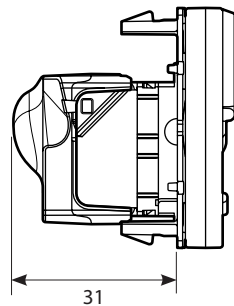

**7. USUAL CONNECTION OF RJ 45S**

Accepts the following cable connectors:  
 RJ11 (4 contacts), RJ12 (6 contacts), RJ45 (9 contacts).  
 Double colour code EIA - TIA 568 A and B on terminals:  
 - UTP 8 contacts  
 - FTP 9 contacts  
 - STP 9 contacts 360° screen

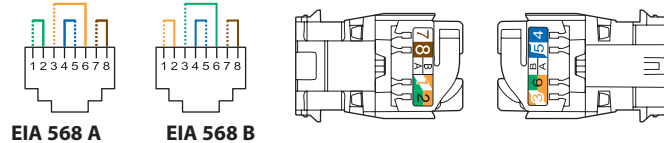

Conductors supported:  
 - Single-wire: 0.5 to 0.65 mm, AWG 22 to 25  
 - Multiple-wire: AWG 26  
 - Polyethylene conductor insulation: max Ø with insulation 1.58 mm

**7. USUAL CONNECTION OF RJ 45S (cont.)**

RJ 45 connectors are equipped with a locking nut that does not require the use of a specific tool and which enables re-cabling in the event of error.

This system allows the wire pairs to be spread easily before mounting them

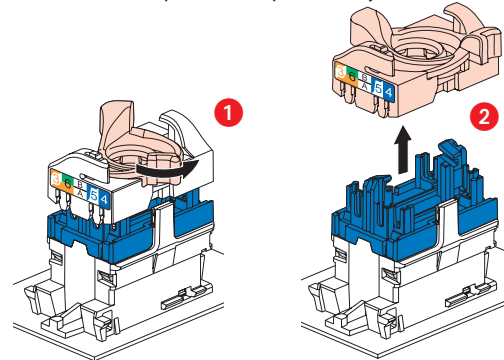

on the connector.  
 Spreading cables ensures that each pair is separated by the specified 13 mm.

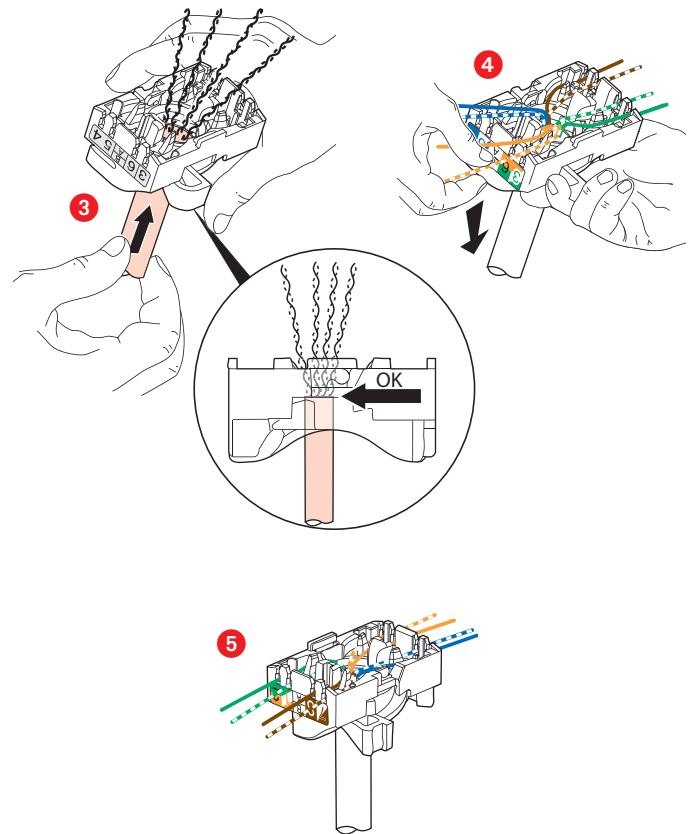

Spreading pairs by 90° in relation to the cable ensures optimum performance.

**8. STANDARDS AND APPROVALS**

Compliant with standards: ISO/IEC 11801 Edition 2  
 CENELEC EN 50173-1 2007  
 ANSI/EIA/TIA 568-C.2  
 IEC series 60603-7

9. PERFORMANCE

9.1 Component performance (RJ 45 connectors)

Return loss

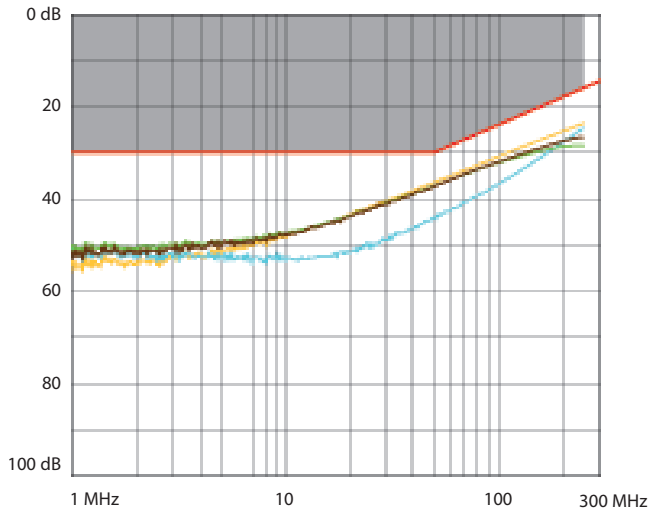

Attenuation

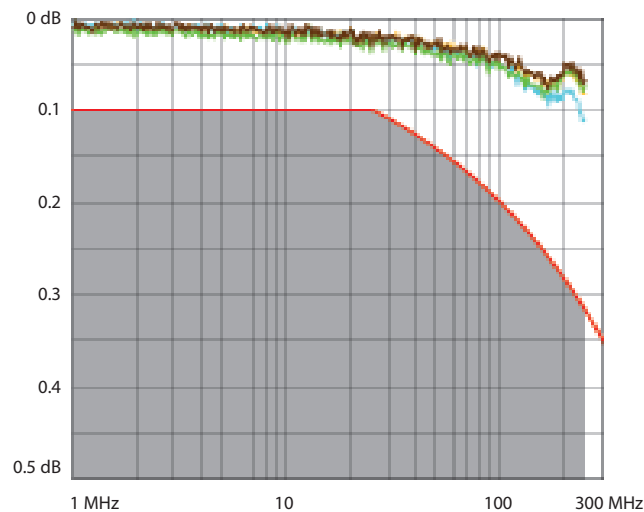

NEXT (Near end Crosstalk Attenuation)

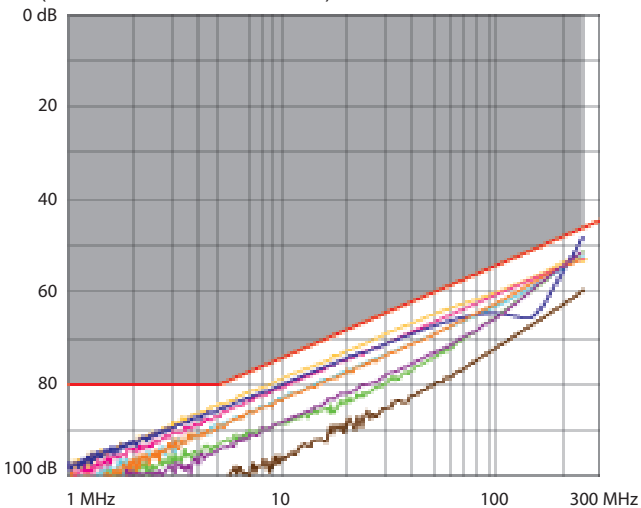

9. PERFORMANCE (cont.)

9.1 Component performance (RJ 45 connectors) (cont.)

FEXT (Far end Crosstalk Attenuation)

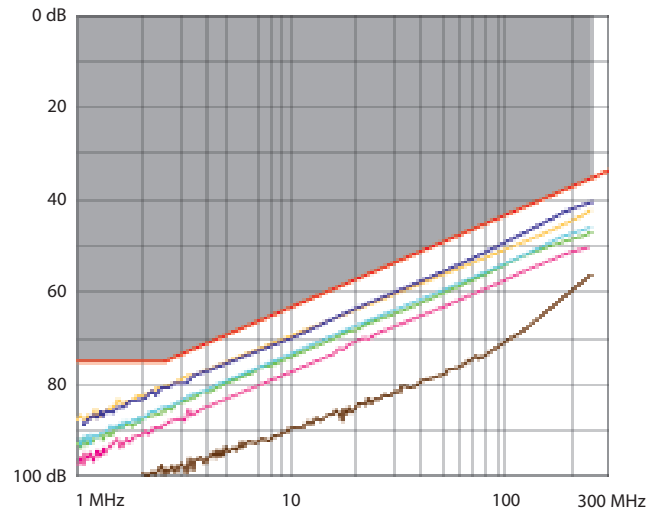

9.2 Performance of permanent link with F/UTP cable

Return loss

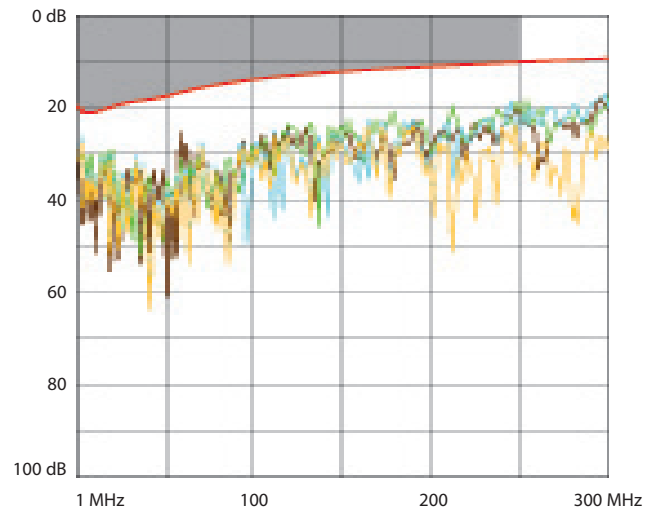

Attenuation

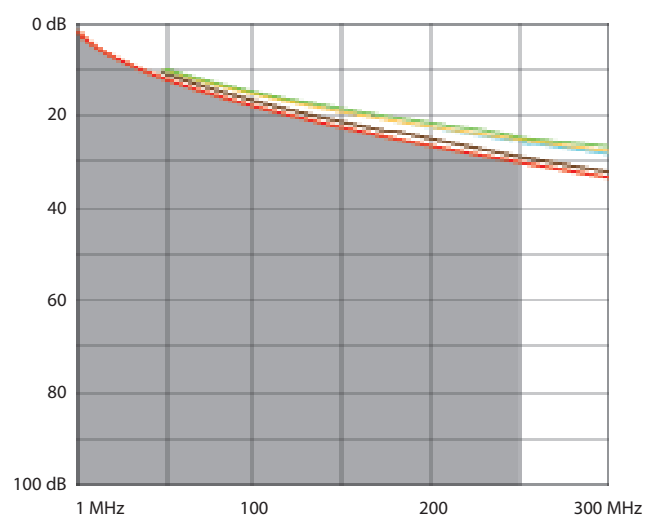

**9. PERFORMANCE (cont.)**

**9.2 Performance of permanent link with F/UTP cable (cont.)**  
 NEXT (Near end Crosstalk Attenuation)

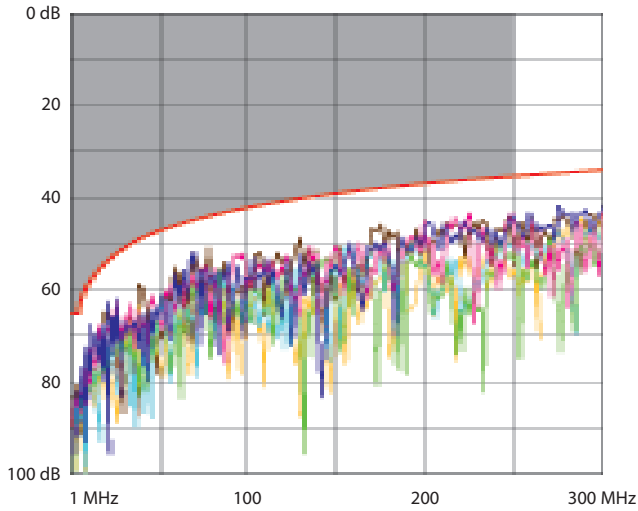

PS NEXT (Power Sum NEXT)

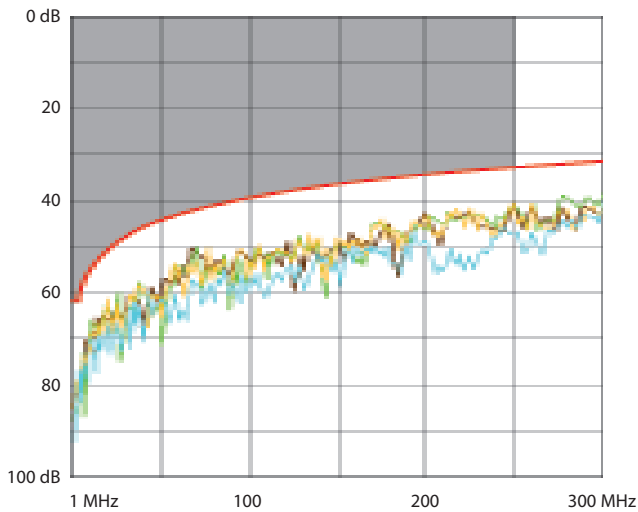

ACR (Attenuation to Crosstalk Ratio)

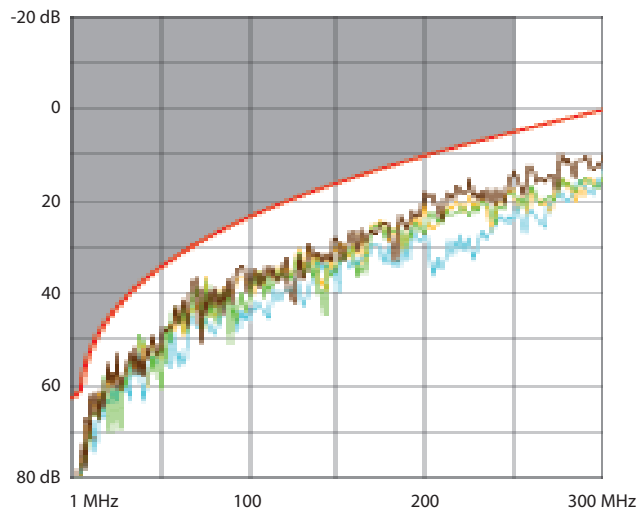

**9. PERFORMANCES (cont.)**

**9.2 Performance of permanent link with F/UTP cable (cont.)**  
 ELFEXT (Equal Level End Crosstalk Attenuation)

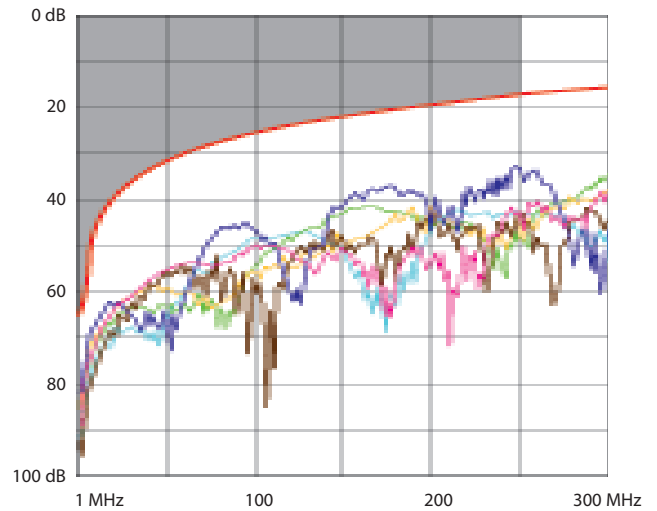

Delay skew

